

nex
importadora

CATÁLOGO COMERCIAL

CONHEÇA



SOBRE NÓS

Desde um pequeno pedido de necessidade urgente ou uma extensa solicitação de fornecimento de maior volume, a NEX está apta e preparada para atendê-lo, fornecendo soluções confiáveis e eficientes, com atendimento personalizado e entrega ágil e simplificada.

Estamos empenhados em fornecer produtos de qualidade, serviços excepcionais e criar parcerias de longo prazo!

Confira nossos produtos →



ÍNDICE DE PRODUTOS



CONECTORES



**TRAVAS
E TERMINAIS**



**FERRAMENTAS
E ACESSÓRIOS**

CONECTORES SÉRIE AT



AT06-2S
2 VIAS - PLUG



AT04-2P
2 VIAS - RECEPTÁCULO



AT06-3S
3 VIAS - PLUG

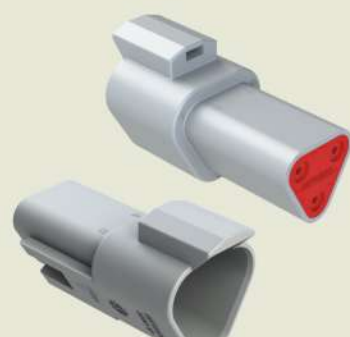

AT04-3P
3 VIAS - RECEPTÁCULO

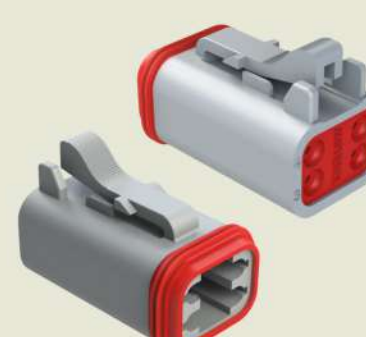

AT06-4S
4 VIAS - PLUG



AT04-4P
4 VIAS - RECEPTÁCULO

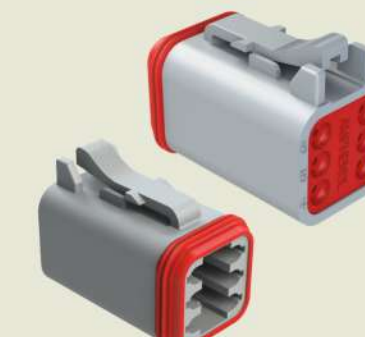

AT06-6S
6 VIAS - PLUG



AT04-6P
6 VIAS - RECEPTÁCULO



AT06-08SA
8 VIAS - PLUG

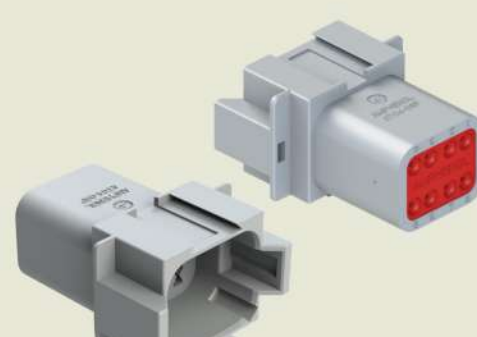

AT04-08PA
8 VIAS - RECEPTÁCULO

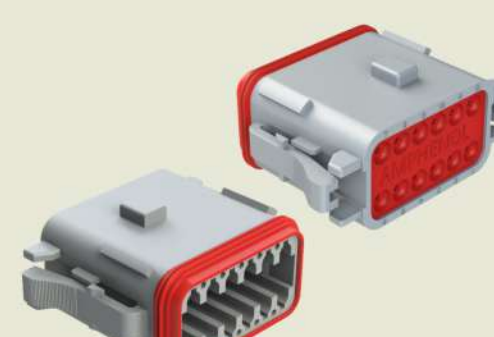

AT06-12SA
12 VIAS - PLUG



AT04-12PA
12 VIAS - RECEPTÁCULO



AT16-18SA-K004
18 VIAS - PLUG

APLICA-SE TRAVAS - PÁGINA 7 | APLICA-SE TERMINAIS

CONNECTORES SÉRIE ATM

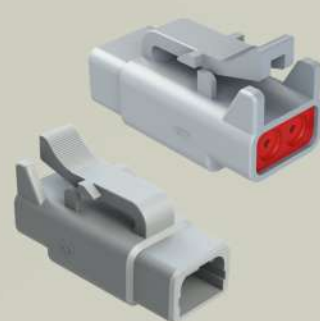

ATM06-2S
2 VIAS - PLUG



ATM04-2P
2 VIAS - RECEPTÁCULO

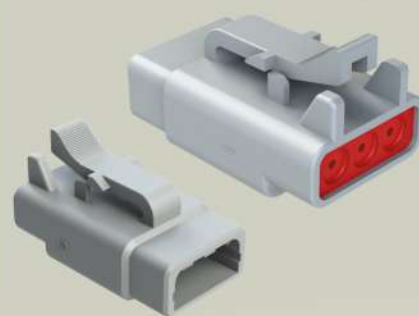

ATM06-3S
3 VIAS - PLUG



ATM04-3P
3 VIAS - RECEPTÁCULO

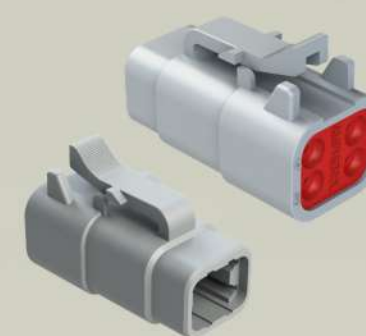

ATM06-4S
4 VIAS - PLUG



ATM04-4P
4 VIAS - RECEPTÁCULO

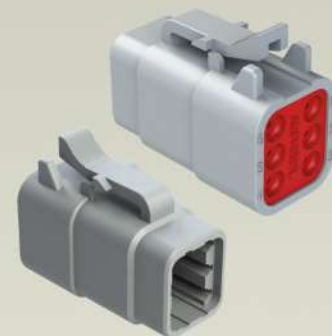

ATM06-6S
6 VIAS - PLUG



ATM04-6P
6 VIAS - RECEPTÁCULO

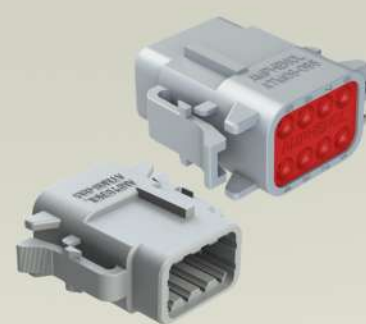

ATM06-08SA
8 VIAS - PLUG



ATM04-08PA
8 VIAS - RECEPTÁCULO

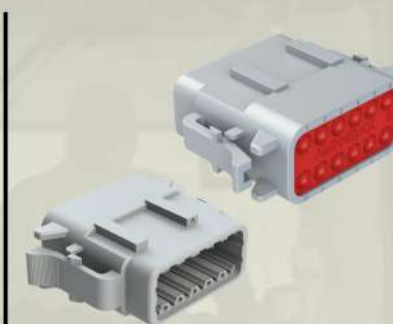

ATM06-12SA
12 VIAS - PLUG



ATM04-12PA
12 VIAS - RECEPTÁCULO



ATM06-12SB
12 VIAS - PLUG
CHAVE B



ATM04-12PB
12 VIAS - RECEPTÁCULO
CHAVE B

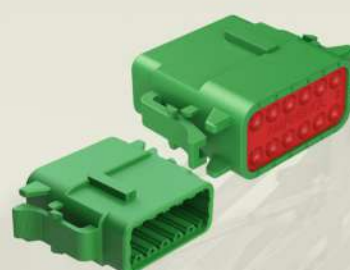

ATM06-12SC
12 VIAS - PLUG
CHAVE C



ATM04-12PC
12 VIAS - RECEPTÁCULO
CHAVE C



ATM06-12SD
12 VIAS - PLUG
CHAVE D



ATM04-12PD
12 VIAS - RECEPTÁCULO
CHAVE D

APLICA-SE TRAVAS - PÁGINA 8 | APLICA-SE TERMINAIS

CONECTORES SÉRIE ATP

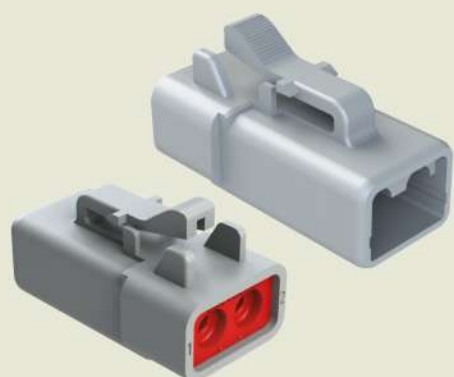

ATP06-2S
2 VIAS - PLUG



ATP04-2P
2 VIAS - RECEPTÁCULO

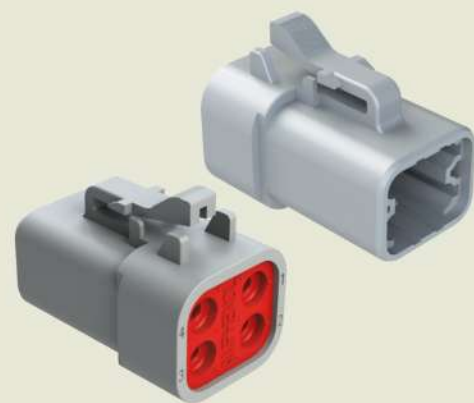

ATP06-4S
4 VIAS - PLUG



ATP04-4P
4 VIAS - RECEPTÁCULO

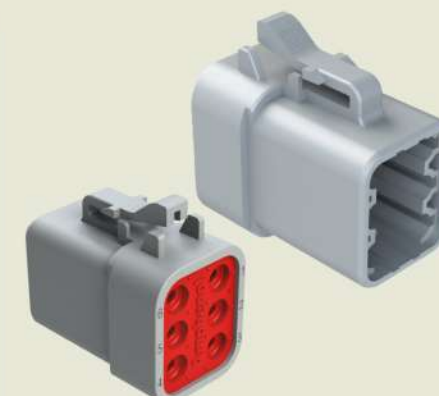

ATP06-6S
6 VIAS - PLUG



ATP04-6P
6 VIAS - RECEPTÁCULO

CONECTORES SÉRIE ATHD



ATHD06-1-4S
1 VIA - PLUG - 4AWG



ATHD04-1-4P
1 VIA - RECEPTÁCULO - 4AWG



ATHD06-1-8S
1 VIA - PLUG - 8AWG



ATHD04-1-8P
1 VIA - RECEPTÁCULO - 8AWG

APLICA-SE TRAVAS - PÁGINA 8 | APLICA-SE TERMINAIS

TRAVAS SÉRIE AT

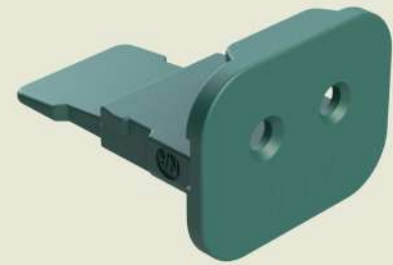

AW2S
2 VIAS - PLUG

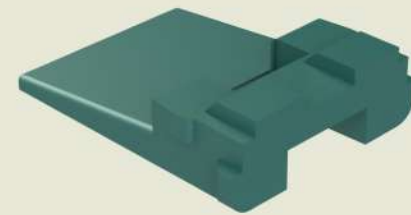

AW2P
2 VIAS - RECEPTÁCULO

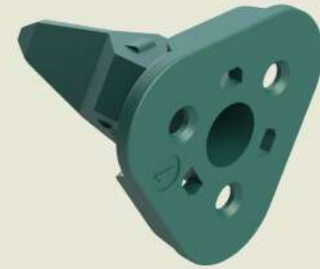

AW3S
3 VIAS - PLUG

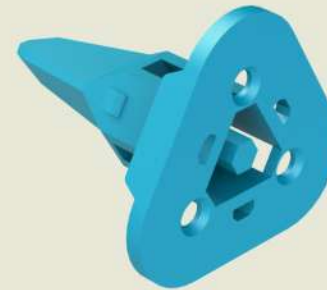

AW3S-1939
3 VIAS - PLUG

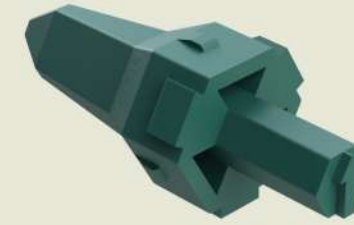

AW3P
3 VIAS - RECEPTÁCULO

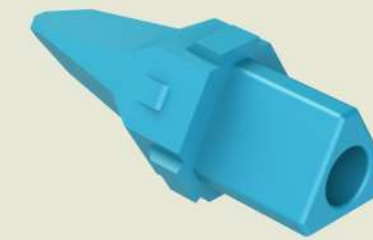

AW3P-1939
3 VIAS - RECEPTÁCULO



AW4S
4 VIAS - PLUG

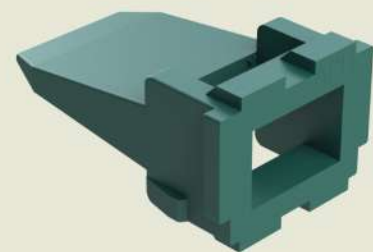

AW4P
4 VIAS - RECEPTÁCULO

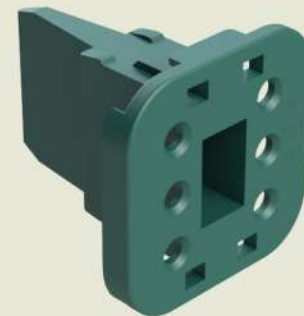

AW6S
6 VIAS - PLUG

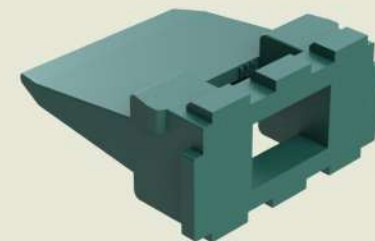

AW6P
6 VIAS - RECEPTÁCULO



AW8S
8 VIAS - PLUG

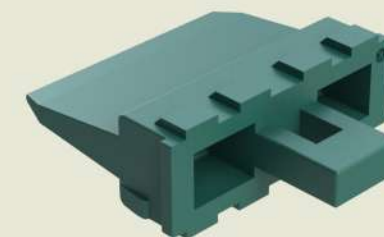

AW8P
8 VIAS - RECEPTÁCULO

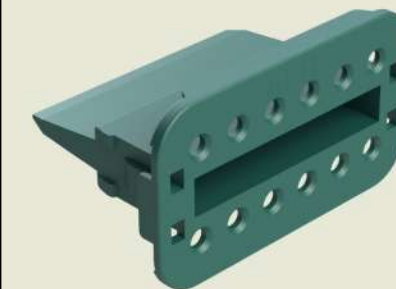

AW12S
12 VIAS - PLUG

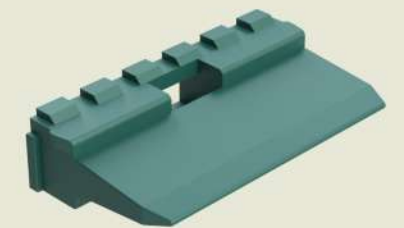

AW12P
12 VIAS - RECEPTÁCULO

TRAVAS SÉRIE ATM

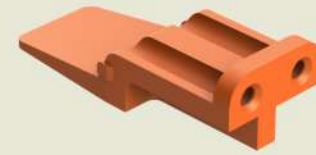

AWM-2S
2 VIAS - PLUG

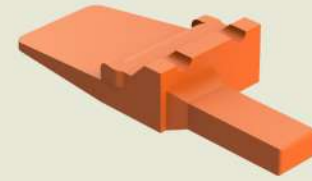

AWM-2P
2 VIAS - RECEPTÁCULO



AWM-3S
3 VIAS - PLUG

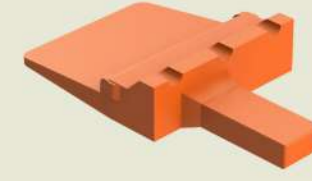

AWM-3P
3 VIAS - RECEPTÁCULO



AWM-4S
4 VIAS - PLUG

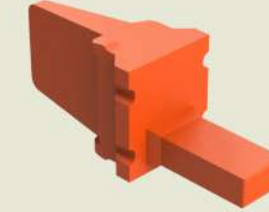

AWM-4P
4 VIAS - RECEPTÁCULO

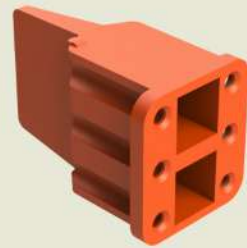

AWM-6S
6 VIAS - PLUG

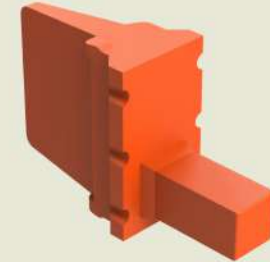

AWM-6P
6 VIAS - RECEPTÁCULO

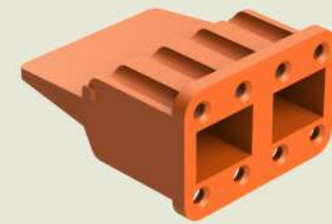

AWM-8S
8 VIAS - PLUG



AWM-8P
8 VIAS - RECEPTÁCULO

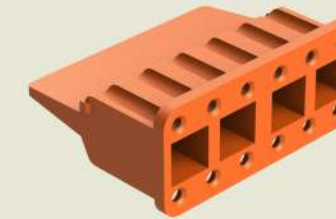

AWM-12S
12 VIAS - PLUG



AWM-12P
12 VIAS - RECEPTÁCULO

TRAVAS SÉRIE ATP



AWP-2S
2 VIAS - PLUG



AWP-2P
2 VIAS - RECEPTÁCULO



AWP-4S
4 VIAS - PLUG



AWP-4P
4 VIAS - RECEPTÁCULO

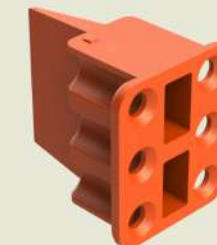

AWP-6S
6 VIAS - PLUG



AWP-6P
6 VIAS - RECEPTÁCULO

CONECTORES SÉRIE ARC



ARC16-24SA-P013
24 VIAS - PLUG



ARC12-24PA
24 VIAS - RECEPTÁCULO



ARC16-40S-P013
40 VIAS - PLUG



ARC12-40PA
40 VIAS - RECEPTÁCULO



ARC26-50S04
50 VIAS - PLUG



ARC20-50P04-BM01SP1
50 VIAS - RECEPTÁCULO



ARC26-60S04
60 VIAS - PLUG



ARC20-60P04-BM01SP1
60 VIAS - RECEPTÁCULO



ARC16-70SA-P013
70 VIAS - PLUG



ARC12-70PA
70 VIAS - RECEPTÁCULO

APLICA-SE TERMINAIS

CONECTORES SÉRIE AHD



AHD16-3-96S
3 VIAS - PLUG

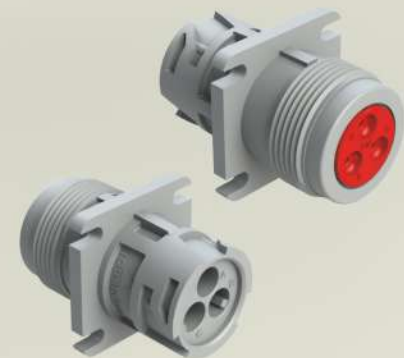

AHD10-3-96P
3 VIAS - RECEPTÁCULO



AHD16-5-16S
5 VIAS - PLUG



AHD10-5-16P
5 VIAS - RECEPTÁCULO



AHD16-6-12S
6 VIAS - PLUG



AHD10-6-12P
6 VIAS - RECEPTÁCULO



AHD16-6-96S
6 VIAS - PLUG



AHD10-6-96P
6 VIAS - RECEPTÁCULO



AHD16-9-1939S
9 VIAS - PLUG



AHD10-9-1939P
9 VIAS - RECEPTÁCULO

APLICA-SE TERMINAIS

CONNECTORES SÉRIE AHDP



AHDP06-18-06SN-SRA
6 VIAS - PLUG



AHDP04-18-06PN-SRA
6 VIAS - RECEPTÁCULO



AHDP06-18-08SN-SRA
8 VIAS - PLUG



AHDP04-18-08PN-SRA
8 VIAS - RECEPTÁCULO



AHDP06-18-14SN-SRA
14 VIAS - PLUG



AHDP04-18-14PN-SRA
14 VIAS - RECEPTÁCULO



AHDP06-18-14PN-SRA
14 VIAS - PLUG - INVERTIDO



AHDP04-18-14SN-SRA
14 VIAS - RECEPTÁCULO - INVERTIDO



AHDP06-18-20SN-SRA
20 VIAS - PLUG



AHDP04-18-20PN
20 VIAS - RECEPTÁCULO



AHDP06-18-21SN-SRA
21 VIAS - PLUG



AHDP04-18-21PN
21 VIAS - RECEPTÁCULO



AHDP06-24-91SN-SRA
9 VIAS - PLUG - ISO



AHDP04-24-91PN-SRA
9 VIAS - RECEPTÁCULO - ISO



AHDP06-24-09SN-SRA
9 VIAS - PLUG



AHDP04-24-09PN-SRA
9 VIAS - RECEPTÁCULO



AHDP06-24-14SN-SRA
14 VIAS - PLUG



AHDP04-24-14PN-SRA
14 VIAS - RECEPTÁCULO

APLICA-SE TERMINAIS

CONNECTORES SÉRIE AHDP



AHDP06-24-16SN-SRA
16 VIAS - PLUG



AHDP04-24-16PN-SRA
16 VIAS - RECEPTÁCULO



AHDP06-24-18SN-SRA
18 VIAS - PLUG



AHDP04-24-18PN-SRA
18 VIAS - RECEPTÁCULO



AHDP06-24-19SN-SRA
19 VIAS - PLUG



AHDP04-24-19PN-SRA
19 VIAS - RECEPTÁCULO



AHDP06-24-23SN-SRA
23 VIAS - PLUG



AHDP04-24-23PN-SRA
23 VIAS - RECEPTÁCULO



AHDP06-24-29SR-SRA
29 VIAS - PLUG



AHDP04-24-29PR-SRA
29 VIAS - RECEPTÁCULO



AHDP06-24-31SR-SRA
31 VIAS - PLUG



AHDP04-24-31PR-SRA
31 VIAS - RECEPTÁCULO



AHDP06-24-35SR-SRA
35 VIAS - PLUG



AHDP04-24-35PR-SRA
35 VIAS - RECEPTÁCULO



AHDP06-24-47SR-SRA
47 VIAS - PLUG



AHDP04-24-47PR-SRA
47 VIAS - RECEPTÁCULO

APLICA-SE TERMINAIS

CONECTORES SÉRIE AHDM



AHDM06-18-14SN
14 VIAS - PLUG



AHDM04-18-14PN
14 VIAS - RECEPTÁCULO



AHDM06-18-20SR
20 VIAS - PLUG



AHDM04-18-20PR
20 VIAS - RECEPTÁCULO



AHDM06-24-91SN
9 VIAS - PLUG - ISO



AHDM04-24-91PN
9 VIAS - RECEPTÁCULO - ISO



AHDM06-24-91SR-B019
9 VIAS - PLUG



AHDM04-24-91PR-B019
9 VIAS - RECEPTÁCULO



AHDM06-24-14SN
14 VIAS - PLUG



AHDM04-24-14PN
14 VIAS - RECEPTÁCULO



AHDM06-24-16SN
16 VIAS - PLUG



AHDM04-24-16PR
16 VIAS - RECEPTÁCULO



AHDM06-24-19SR
19 VIAS - PLUG



AHDM04-24-19PR
19 VIAS - RECEPTÁCULO



AHDM06-24-23SR
23 VIAS - PLUG



AHDM04-24-23PR
23 VIAS - PLUG



AHDM06-24-27SR
27 VIAS - PLUG



AHDM04-24-27PR
27 VIAS - RECEPTÁCULO



AHDM06-24-31SR
31 VIAS - PLUG



AHDM04-24-31PR
23 VIAS - RECEPTÁCULO



AHDM06-24-31ST-B019
31 VIAS - PLUG



AHDM04-24-31PT-B019
31 VIAS - RECEPTÁCULO

APLICA-SE TERMINAIS

TERMINAIS ESTAMPADOS



AT62-20-0122
20 AWG - SOQUETE



AT60-20-0122
20 AWG - PINO



AT62-16-0122
16 AWG - SOQUETE



AT60-16-0122
16 AWG - PINO



AT62-14-0122
14 AWG - SOQUETE



AT60-14-0122
14 AWG - PINO



AT62-12-0166
12 AWG - SOQUETE



AT62-12-0222
12 AWG - SOQUETE



AT60-12-0166
12 AWG - PINO



AT60-12-0222
12 AWG - PINO

TERMINAIS SÓLIDOS



AT62-201-20141
20 AWG - SOQUETE



AT60-202-20141
20 AWG - PINO



AT62-201-16141
16 AWG - SOQUETE

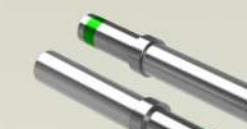

AT62-209-16141
14 AWG - SOQUETE



AT60-202-16141
16 AWG - PINO

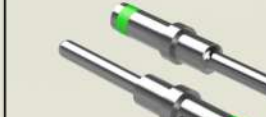

AT60-215-16141
14 AWG - PINO



AT62-203-12141
12 AWG - SOQUETE



AT60-204-12141
12 AWG - PINO



AT62-203-08141
8 AWG - SOQUETE



AT60-204-08141
8 AWG - PINO



AT62-203-04141
4 AWG - SOQUETE



AT60-204-0490
4 AWG - PINO

FERRAMENTAS



AT11-240-2005
EXTRATOR 20 AWG



AT11-310-1605
EXTRATOR 16 AWG



AT11-337-1205
EXTRATOR 12 AWG



AT114008
EXTRATOR 8 AWG



AT11-001-3.6M
EXTRATOR 8 AWG

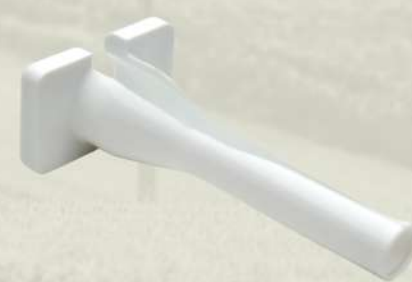

AT114009
EXTRATOR 4 AWG



AT11-027-0405
EXTRATOR 4 AWG



ATRT-100
EXTRATOR DE TRAVAS
E TERMINAIS

ACESSÓRIOS



AT14017
SELO VEDAÇÃO
16/12 AWG



AT13-204-2005
SELO VEDAÇÃO
20 AWG



AT27-004-1200
CLIP DE MONTAGEM



AHDP18-PN01
PORCA PLÁSTICA
SHELL 18



AHDP24-PN01
PORCA PLÁSTICA
SHELL 24



AT12264
ARRUELA METÁLICA
SHELL 24



AT14-001-2486
ARRUELA METÁLICA
SHELL 24



AT14-002-1886
ARRUELA METÁLICA
SHELL 24



AHDMBS-18-059
PRENSA CABO
SHELL 18



AHDMBS-24-059
PRENSA CABO
SHELL 24

FALE COM A **NOSSA EQUIPE**

COMERCIAL@NEXIMPORTADORA.COM.BR

CONTATO@NEXIMPORTADORA.COM.BR

CONTATO

(48) 99156-9395

CONTATO

(48) 3054-1602

WWW.NEXIMPORTADORA.COM.BR |  [@NEXIMPORTADORA](https://www.instagram.com/NEXIMPORTADORA)