

REVISIONS					
REV	ECO	DESCRIPTION	DATE	BY	APPR
A3		RELEASE NEW DWG FORMAT	24/JUL/13	DRP	

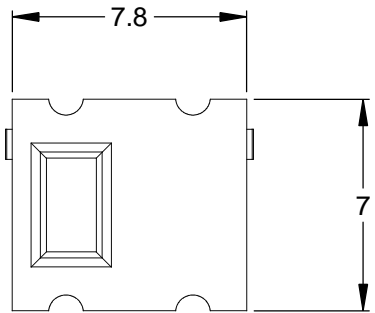
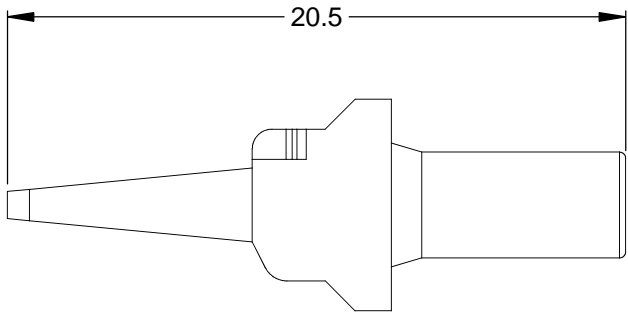
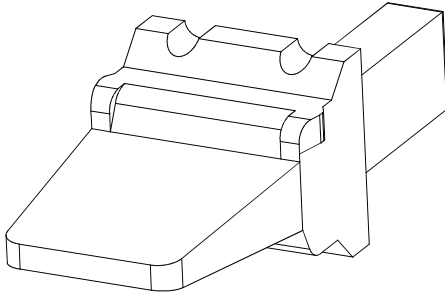
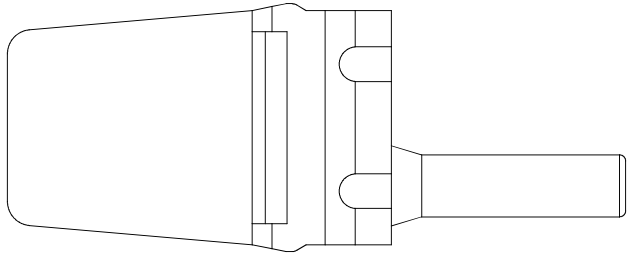

NOTES: UNLESS OTHERWISE SPECIFIED

1. MATERIAL: THERMOPLASTIC; COLOR: ORANGE
2. RoHS COMPLIANT
3. CAVITIES: 4
4. KEYED: N/A
5. USE WITH CONNECTORS: ATM04-4P*
(* = MODIFICATIONS AND COLORS)
6. ALL DIMENSIONS ARE FOR REFERENCE USE ONLY.

AWM-4P						
PART NUMBER		DESCRIPTION				ITEM
QUANTITY	MATERIALS LIST					
UNLESS OTHERWISE SPECIFIED		SIGNATURES		DATE		<h1 style="text-align: center;">Amphenol</h1> <p style="text-align: center;">Sine Systems - www.amphenol-sine.com 44724 Morley Drive Clinton Township, MI 48036</p> <p style="text-align: center;">P-WEDGELOCK, 4 POSITION, ATM SERIES</p>
1) All dimensions are in metric(mm).		DRAWN: D.PARKS		24/JUL/13		
2) Tolerances are as follows:		CHECKED:				
1 PL DEC ±0.30		ENGINEER:				
2 PL DEC ±0.15		APPROVAL:				
3 PL DEC ±0.08		CUSTOMER:				
3) Note reference =		THIS DRAWING IS SUPPLIED FOR INFORMATION ONLY. DESIGN FEATURES, SPECIFICATIONS AND PERFORMANCE DATA SHOWN HEREON ARE THE PROPERTY OF THE AMPHENOL CORPORATION. NO RIGHTS OF REPRODUCTION ARE IMPLIED. ALL DIMENSIONS ARE SUBJECT TO NORMAL MANUFACTURING VARIATIONS.				
MATERIAL SPECIFICATIONS:		SIZE	TYPE	DWG NO:	REVISION	
PROCESS SPECIFICATIONS:		A	C-	AWM-4P	A3	
NEXT ASSY:		SCALE: NONE		SHEET 1 OF 1		